



Tre System design  
Centro Ricerche Fantoni Anna Seravalli

Operative  
Office System

# TRE

**fantoni**

**Numero perfetto.** Le tre dimensioni dell'ufficio di oggi: libertà, vivibilità, personalità. Una soluzione unica: la collezione Tre. Lunghi tavoli componibili, versatili elementi di servizio, colori e accessori che trasformano ogni posto di lavoro in un piccolo mondo personale. **A perfect number.** The three dimensions of the modern-day office: freedom, practicality and personality. A unique solution: the Tre collection. Long modular tables, versatile service units, colours and accessories that give each work station an individual touch. **Die perfekte Zahl.** Die drei Dimensionen im Büro von heute: Freiheit, Lebensqualität, Persönlichkeit. Eine Lösung: die Kollektion Tre. Lange, kombinierbare Tische, vielseitige Beistellelemente, Farben und Zubehör, die jeden Arbeitsplatz in eine kleine, individuelle Welt verwandeln. **Nombre parfait.** Les trois dimensions du bureau d'aujourd'hui : liberté, vivabilité, personnalité. Une solution unique : la collection Tre. Longs bureaux composables, éléments de service polyvalents, couleurs et accessoires qui transforment chaque poste de travail en un petit monde personnel. **Número perfecto.** Las tres dimensiones de la oficina de hoy: libertad, habitabilidad, personalidad. Una solución única: la colección Tre. Mesas largas componibles, elementos de servicio versátiles, colores y accesorios que transforman cada puesto de trabajo en un pequeño universo personal.



**Possibilità extra.**

Il tavolo "Extra Long" può raggiungere una lunghezza di 360 cm ed è proposto in una gamma completa di varianti: dalla semplice scrivania con fiancate, al tavolo a ponte da sovrapporre al tavolo di servizio per creare composizioni che estendono le tradizionali funzioni e valenze estetiche delle postazioni operative.

**Extra possibilities.**

The "Extra Long" table can be up to 360 cm in length and is available in a wide range of versions: from a simple desk with side panels to a bridging table that can be positioned over a service table to create configurations that extend the traditional functions and aesthetic values of work stations.

**Möglichkeit extra.**

Der Tisch "Extra Long" kann eine Länge von 360 cm erreichen und wird in einem kompletten Programm von Ausführungen angeboten: vom einfachen Schreibtisch mit Seitenteil bis zum Tisch, der als Brücke über dem Beistelltisch eingesetzt wird, um Kompositionen entstehen zu lassen, die Funktion und Ästhetik traditioneller Arbeitsplätze erweitern.

**Possibilités extra.**

Le bureau "Extra Long" peut atteindre une longueur de 360 cm et est proposé dans une gamme complète de variantes: du simple bureau avec piétements latéraux constitués d'un panneau plein, à la table en pont à superposer à la table de service, pour créer des compositions qui augmentent les fonctions traditionnelles et les qualités esthétiques des postes de travail.

**Posibilidades extra.**

La mesa "Extra Long" puede alcanzar una longitud de 360 cm y se propone en una gama completa de variantes: del simple escritorio con costados, a la mesa con configuración en forma de puente para superponer a la mesa de servicio y crear composiciones que amplían las funciones tradicionales y los valores estéticos de los puestos operativos.







## 10 Molteplici sviluppi.

L'architettura del posto di lavoro prende forma per accostamenti e sovrapposizioni di tavoli "Extra Long", schermi divisorii, cassettiere portanti ed elementi a giorno, in un libero gioco di piani, volumi, geometrie e colori.

### Unlimited expansion.

The architecture of the work station takes shape by placing "Extra Long" tables, divider screens, supporting drawer boxes and open units next to and over each other, in a free play of surfaces, volumes, geometries and colours.

### Vielfältige Entwicklungen.

Der Aufbau von Arbeitsplätzen nimmt Form an: durch Kombination und Überlagerung von Tischen "Extra Long", Trennschirmen, tragenden Schubladenkästen und offenen Schrankelementen, alles im beliebigen Spiel mit Platten, Volumen, Geometrien und Farben.

### Développements multiples.

L'architecture du poste de travail prend forme par juxtapositions et superpositions de bureaux "Extra Long", panneaux écran, caissons porteurs et éléments ouverts, en un libre jeu de plans, volumes, géométries et couleurs.

### Desarrollos múltiples.

La arquitectura del puesto de trabajo adquiere forma gracias a las combinaciones y a las superposiciones de las mesas "Extra Long", paneles separadores, cajoneras de soporte y elementos sin puertas, en un juego libre de planos, volúmenes, geometrias y colores.

## 11 Tre Collection





**Naturale ispirazione.**

Un ulteriore elemento caratterizzante: il decoro che riprende, idealizzandola, le venature della foglia di faggio, l'albero utilizzato per la produzione di MDF Fantoni. È disponibile, su richiesta, sulle fiancate dei tavoli, sugli schermi divisori e sulle sedute.

**Natural inspiration.**

Another striking feature: the decoration that is a stylised representation of veins in a beech leaf, the tree used to produce Fantoni Medium Density Fibreboard. This is available, on request, on the table side panels, divider screens and chairs.

**Natürliche Inspiration.**

Ein weiteres, charakteristisches Element: eine Dekoration, die auf stilisierte Weise die Äderung von Buchenblättern darstellt, dem Baum, der für die Erzeugung von Medium Density Fibreboard (MDF) Fantoni verwendet wird. Auf Wunsch gibt es diese Dekoration auf den Seitenteilen der Tische, auf Trennschirmen und Sitzmöbeln.

**Inspiration naturelle.**

Un autre élément caractérisant : le décor qui reprend, en le stylisant, les veines de la feuille de hêtre, l'arbre utilisé pour la production du MDF Fantoni. Il est disponible, sur demande, sur les plètements latéraux des bureaux, sur les panneaux écran et sur les sièges.

**Inspiración natural.**

Otro elemento de caracterización: la decoración que reproduce, idealizándolas, las vetas de la hoja de haya, el árbol utilizado para la producción del MDF Fantoni. A petición, está disponible en los costados de las mesas, en los paneles separadores y en los asientos.

**Contenuti accessibili.**

Il contenitore a giorno è un altro versatile elemento a disposizione per rendere più funzionale e accogliente lo spazio di lavoro. In versione da appoggio, fruibile da entrambi i lati, oppure in versione sospesa sottopiano, permette di creare un archivio personale, sempre a portata di mano.

**Easy access.**

The open storage unit is another versatile component available to make work space more functional and welcoming. Available in versions for placing on top of the table, at either end, or for suspending under the top, they can be used to create a personal filing area that is always close at hand.

**Zugängliche Inhalte.**

Mit den offenen Schrankelementen ist ein weiteres, flexibles Element verfügbar, um den Arbeitsbereich noch zweckmäßiger und angenehmer zu gestalten. In der am Boden aufliegenden Ausführung, die beidseitig zugänglich ist, oder als Hängeelement unter der Arbeitsplatte, gibt das Möbel Gelegenheit, ein persönliches Archiv einzurichten, das immer in Reichweite ist.

**Contenus accessibles.**

L'armoire ouverte est un autre élément polyvalent à disposition, pour rendre l'espace de travail plus fonctionnel et accueillant. Dans la version à poser, accessible des deux côtés, ou dans la version suspendue sous le plan, elle permet de créer des archives personnelles, toujours à portée de la main.

**Contenidos accesibles.**

El armario sin puertas es otro elemento versátil a disposición, para hacer que el espacio de trabajo sea más funcional y acogedor. En versión de apoyo, que puede ser utilizada de ambos lados, o bien suspendida debajo del tablero, permite crear un archivo personal, siempre al alcance de mano.









**Colorata  
funzionalità.**

Il mobile di servizio offre una superficie da appoggio per tecnologie e materiali di lavoro da condividere con i colleghi, ma allo stesso tempo rappresenta un elemento estetico, introducendo la valenza espressiva di colori di tendenza: amaranto, verde, glicine e giallo, in abbinamento al grigio nebbia e al rovere.

**Colourful  
functionality.**

The service unit provides a surface on which to place office equipment and materials to be shared between co-workers, while at the same time enhancing overall appearance by introducing the expressive value of fashionable colours: amaranth, green, wisteria and yellow, combined with misty grey and oak.

**Farbige  
Zweckmäßigkeit.**

Mit dem Beistellmöbel wird eine Auflagefläche für Technologien und Arbeitsunterlagen geboten, die mit Kollegen geteilt wird, aber gleichzeitig ist es ein ästhetisches Element, das eine neue, expressive Dimension durch trendige Farben hinzufügt: Amaranthrot, Grün, Flieder und Gelb, in Verbindung mit Nebelgrau und Eiche.

**Fonctionnalité  
colorée.**

Le meuble de service offre une surface d'appui pour les équipements bureautiques et le matériel de travail à partager avec les collègues, mais il représente en même temps un élément esthétique introduisant la force expressive des couleurs mode: amarante, vert, glycine et jaune, associé au gris brouillard et au chêne.

**Funcionalidad  
colorada.**

El mueble de servicio ofrece una superficie de apoyo para las tecnologías y los materiales de trabajo que se comparten con los compañeros de trabajo, pero que al mismo tiempo representa un elemento estético, introduciendo la característica expresividad de los colores de tendencia: granata, verde, glicina y amarillo, combinado con el gris niebla y el roble.

**Vivere l'ufficio.**

Oltre che essere utilizzata come ampio portaoggetti e portacarte, la vaschetta in plexiglas trasparente può essere completata con un ripiano in plastica nera a tenuta di liquidi, che permette il suo impiego per gli usi più diversi: da vassoio per la pausa del pomeriggio, a giardino bonsai da ufficio.

**At home in the office.**

As well as being used as a handy storage compartment and document holder, the transparent Plexiglas tray can be fitted with a black, plastic, liquid-proof shelf suitable for a variety of uses: tray for afternoon coffee/tea break, stand for office bonsai.

**Lebensqualität im Büro.**

Die durchsichtige Plexiglas-Schale ist nicht nur eine aufnahmefähige Ablage für diverse Utensilien und Papier, sondern sie kann auch durch einen wasserdichten Einlegeboden aus schwarzem Kunststoff ergänzt werden, um für unterschiedliche Verwendungen geeignet zu sein: als Tablett für die Nachmittagsjause oder als Bonsai-Garten für das Büro.

**Vivre le bureau.**

En plus d'être utilisé pour les menus objets ou les documents, le bac en plexiglas transparent peut être complété par une tablette en plastique noir, étanche aux liquides, qui permet de l'utiliser pour les fonctions les plus variées : comme plateau pour la pause de l'après-midi, ou comme jardin bonsai pour le bureau.

**Vivir la oficina.**

No se usa solamente como un amplio portaobjetos y portapapeles, la bandeja en plexiglas transparente puede completarse con un estante de plástico negro estanco, que puede usarse para los fines más variados: de la bandeja para el intermedio de la tarde, al jardín bonsai de oficina.





**Tre per tutti.** I tavoli sagomati permettono di creare delle composizioni multiple, capaci di riunire in un'unica postazione di lavoro, tutte le diverse valenze dell'ufficio contemporaneo: ergonomia e creatività, colore e rigore, modularità e personalizzazione. **Three for all.** Shaped tables make it possible to create multiple configurations, combining all the advantages of the contemporary office in a single work station: ergonomic design and creativity, colour and clean lines, modularity and personalisation. **Drei für alle.** Mit den besonders geformten Tischen können Mehrfachplätze zusammengestellt werden, um alle Anforderungen, die an ein modernes Büro gestellt werden, mit einer Arbeitsstation erfüllen zu können: Ergonomie und Kreativität, Farbe und Rigorosität, Modulbauweise und individuelle Gestaltung. **«Tre» pour tous.** Les bureaux non linéaires permettent de créer des compositions multiples, capables de réunir dans une unique poste de travail, toutes les qualités du bureau contemporain : ergonomie et créativité, couleur et rigueur, modularité et personnalisation. **Tre para todos.** Las mesas curvadas permiten crear composiciones múltiples, capaces de reunir en una estación única de trabajo, todas las fuerzas que califican la oficina contemporánea: ergonomía y creatividad, color y rigor, modularidad y personalización.





**Libere associazioni.**

Piani sagomati a 90° e 120°, top di raccordo, piani rettangolari anche su misura, basi metalliche a T o cilindriche si affiancano agli altri elementi della collezione: dai tavoli di servizio, ai contenitori, agli schermi divisorii, permettendo la massima libertà di progettazione, organizzazione e utilizzo dello spazio.

**Free associations.**

Shaped surfaces at 90° and 120°, connecting tops, rectangular surfaces which can also be made to measure and metal T-shaped or cylindrical bases combine with other components of the collection: from service tables to storage units and divider screens. They allow maximum freedom for designing, organising and using space.

**Freie Assoziationen.**

Platten auf 90° und auf 120°, Verbindungsplatten, rechteckige Platten auch nach Maß, metallische Untergestelle aus T-Profil oder zylindrisch, können mit anderen Elementen der Kollektion verbunden werden: Beistelltische, Schrankelemente und Trennschirme geben maximale Freiheit in Planung, Organisation und Nutzung von Räumen.

**Associations libres.**

Plans découpés à 90° et à 120°, plans de liaison, plans rectangulaires également sur mesure, piètements métalliques en T ou cylindriques, ils se juxtaposent aux autres éléments de la collection : des tables de service, aux armoires, aux panneaux écran, permettant la plus grande liberté de projet, d'organisation et d'utilisation de l'espace.

**Libres asociaciones.**

Tableros curvados de 90° y 120°, encimera de unión, tableros rectangulares también a medida, bases metálicas en forma de T o cilíndricas, se combinan con otros elementos de la colección: mesas de servicio, armarios y paneles separadores, permitiendo la máxima libertad de proyecto, organización y uso del espacio.





**Atmosfera leggera.**

L'originale decoro stilizzato può essere realizzato anche sugli ampi tavoli da riunione rettangolari, di lunghezza 240 cm, nonché sullo schienale delle sedute coordinate, realizzate con un'unica scocca in multistrato curvato: un segno di naturale calore e di luminosa leggerezza.

**Light atmospheres.**

The unusual, stylised decoration is also available on large, 240 cm long meeting tables and on the backrests of coordinating chairs, made using a one-piece shell in curved plywood: a hint of natural warmth and bright airiness.

**Ein Hauch Schwerelosigkeit.**

Ebenfalls realisierbar ist die originelle, stilisierte Dekoration auf den großzügigen, rechteckigen Konferenztischen, Länge 240 cm, sowie auf dem Rückteil der dazu passenden Sitzmöbel mit durchgehender Sitzschale aus gebogener Mehrschichtplatte: ein Zeichen für natürliche Wärme und helle Leichtigkeit.

**Atmosphères légères.**

Le décor original stylisé peut être réalisé également sur les grandes tables de réunion rectangulaires, de 240 cm de longueur, ainsi que sur le dossier des sièges assortis, réalisés avec une coque unique en multiplis courbé : un signe de chaleur et de légèreté lumineuse.

**Atmósferas leves.**

La decoración estilizada original puede ser realizada también en las amplias mesas de reunión rectangulares, de 240 cm de longitud, así como en el respaldo de los asientos coordinados, realizados con una estructura única en estratificado curvado: un signo de natural calidez y luminosa ligereza.





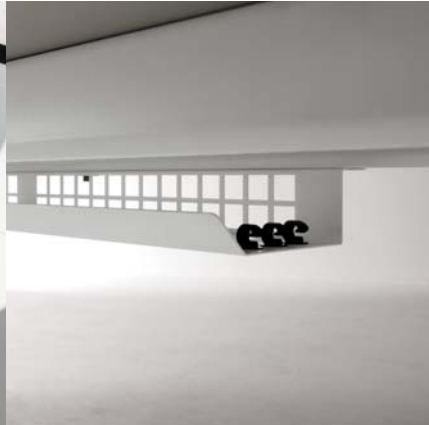

#### Tecnologie essenziali.

Parte integrante del lavoro d'ufficio, la tecnologia si inserisce con discrezione nel design della collezione Tre, sfruttando una serie di soluzioni attentamente studiate per unire funzionalità, accessibilità e immediatezza: canaline trasparenti, vaschette sottopiano, cestelli portacavi, supporti porta CPU.

#### Technology made simple.

Technology, an integral part of office work, blends discretely into the design of the Tre collection, using a number of solutions carefully devised to combine functionality, accessibility and immediateness: transparent ducting, storage trays under the top, cable racks and CPU holders.

#### Essentielle Technologien.

Technologie, ein wesentlicher Teil der Arbeit im Büro, fügt sich mit Diskretion in das Design der Kollektion Tre ein und nutzt dabei eine Reihe sorgfältig entwickelter Lösungen, die Funktionalität, Zugänglichkeit und Unmittelbarkeit garantieren: transparente Kabelkanäle, Schalen unter Tischplatten, Kabelkörbe, Computer-Halterung.

#### Technologies essentielles.

Partie intégrante du travail de bureau, la technologie s'insère avec discrétion dans le design de la collection Tre, en exploitant une série de solutions étudiées attentivement pour associer la fonctionnalité, l'accessibilité et la rapidité : goulottes transparentes, bacs sous le plan, paniers pour câbles, supports pour unité centrale.

#### Tecnologías esenciales.

Parte integrante del trabajo de oficina, la tecnología entra discretamente en el diseño de la colección Tre, aprovechando una serie de soluciones estudiadas atentamente para unir funcionalidad, accesibilidad e immediatez: canales transparentes, bandejas debajo del tablero, cestas portacables, soportes para CPU.

**Organizzare le idee.**

Un'ampia proposta di classificatori e contenitori soddisfa tutte le esigenze pratiche ed estetiche dello spazio ufficio: a giorno, con ante in legno oppure in vetro, con o senza decoro a foglia sui fianchi. Sono inoltre possibili composizioni multiple di contenitori affiancati, sui quali vengono posizionati degli appositi top di finitura dai bordi arrotondati.

**Organising ideas.**

A wide range of filing units and cabinets meet all the practical and aesthetic needs in the office: open, with wood or glass doors, with or without leaf design on the sides. Several cabinets can also be placed side-by-side and covered with special, rounded-edge finishing tops to create multiple configurations.

**Ideen organisieren.**

Durch ein breites Angebot von Akten- und Schrankmöbeln können sowohl die praktischen als auch ästhetischen Anforderungen an den modernen Bürobereich erfüllt werden: offen, mit Holz- oder Glasüren, mit oder ohne Blattmotiv auf den Seitenteilen. Außerdem können Schrankelemente zu mehrfachen Kompositionen aneinandergereiht und durch Oberplatten mit gerundeten Kanten abgeschlossen werden.

**Organiser les idées.**

Une proposition variée de classeurs et armoires satisfait toutes les exigences pratiques et esthétiques de l'espace bureau : sans portes, avec portes, avec portes en bois ou en verre, avec ou sans décor de feuilles sur les côtés. Possibilité de compositions multiples d'armoires juxtaposées sur lesquelles sont placés des plateaux de finition avec bords arrondis.

**Organizar las ideas.**

Una amplia propuesta de carpeteros y armarios ofrece una respuesta a todas las exigencias prácticas y estéticas del espacio de oficina: sin puertas, con puertas de madera o de vidrio, con o sin decoración de hojas en los costados. Además, se pueden formar composiciones múltiples de armarios adosados, sobre los cuales se colocan las encimeras de acabado con cantos redondeados.

Informazioni tecniche  
Technical data

Tavolo rettangolare\_Rectangular table, Rechtecker Tisch, Table rectangulaire\_Mesa rectangular

P80 H72  
64-1R20 L 200 64-1R32 L 320  
64-1R24 L 240 64-1R36 L 360  
64-1R28 L 280



Tavolo rettangolare decorato\_Decorated rectangular table, Rechtecker Tisch in Dekorausführung\_Bureau rectangulaire décoré\_Mesa rectangular decorada

P80 H72  
64-1R21 L 200 64-1R33 L 320  
64-1R25 L 240 64-1R37 L 360  
64-1R29 L 280



Tavolo penisola\_Peninsula table, Halbinsel-Tisch, Bureau en épi\_Ala de extensión de mesa

P80 H72  
64-1R40 L 200  
64-1R44 L 240  
64-1R48 L 280



Tavolo penisola decorato\_Decorated peninsula table, Halbinsel-Tisch in Dekorausführung\_Bureau en épi décoré\_Ala de extensión decorada

P80 H72  
64-1R41 L 200  
64-1R45 L 240  
64-1R49 L 280



Tavolo di servizio\_Side table, Beistelltisch, Table de service\_Mesa de servicio

P40 H62  
64-1R60 L 200 64-1R72 L 320  
64-1R64 L 240 64-1R76 L 360  
64-1R68 L 280



Tavolo di servizio decorato, Beistelltisch in Dekorausführung, Decorated side table, Table de service décorée, Mesa de servicio decorada

P40 H62  
64-1R61 L 200 64-1R73 L 320  
64-1R65 L 240 64-1R77 L 360  
64-1R69 L 280



Carter per fianchi tavoli P80\_Casing for sides of P80 tables, Seitenabdeckung fürTische P80\_Enjoliveur pour piétements bureaux P80\_Panel de cubierta para los costados de la mesa P80

L74 P5 H66  
64-1R65 L 240 64-1R77 L 360  
64-1R69 L 280



Carter per fianchi tavoli P40\_Casing for sides of P40 tables, Seitenabdeckung fürTische P40\_Enjoliveur pour piétements bureaux P40\_Panel de cubierta para los costados de la mesa P40

L34 P5 H56  
64-1R98 pz. 1



Cassetiera portante, 3 cassetti, Supporting drawer box, 3 drawers, Tragender Schubladenkasten, 3 Laden, Caisson porteur, 3 tiroirs, Cajonera de soporte, 3 cajones

L42 P57 H58+S  
64-6R89

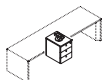

Cassetiera portante, 1cassetto/ 1classif., Supporting drawer box, 1 drawer/ 1 filing drawer, Tragender Schubladenkasten, 1 Ladet/1 Karteausz., Caisson porteur, 1 tiroir/1 classeur, Cajonera de soporte, 1 cajón/1 carpetero

L42 P57 H58+S  
64-6R90



Base per tavoli Extra long H62/72\_Base for Extra Long tables H62/72\_Untergestell fürTische Extra Long H62/72\_Piètement pour bureaux Extra Long H62/72\_Apoyo para mesas Extra Long, H62/72

Ø 6 H72 64-BR87  
Ø 6 H62 64-BR88

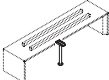

Mobile a giorno, monofronte\_Open-fronted unit with single front panel, Offenes Element, eine Front\_Armario ouverte 1 face\_Armario sin puertas, frente unico

L80 P40 H41  
64-7R18



Mobile bifronte (divisorio plexiglas)\_Unit with double front panel (Plexiglas partition), Element mit zwei Fronten (Trennwand aus Plexiglas)\_Armario ouverte 2 faces (séparation en plexiglas)\_Armario doble frente (divisorio en plexiglas)

L80 P40 H41  
64-7R28

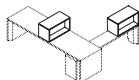

Mobile sospeso monofronte\_Suspended unit with single front panel\_Hängeelement eine Front\_Meuble suspendu 1 face\_Armario suspendido frente único

L80 P40 H41  
64-7R38



Pensile a muro, anta scorrevole\_Wall unit, sliding door\_Hängeschränk, mit Schiebetrür\_Meuble haut, porte coulissante\_Mueble alto, puerta corredera

L160 P32 H41  
64-7R48



Libreria per tavoli penisola\_Bookcase for peninsula tables\_Bücherschränk für Halbinsel-Tische\_Meuble bibliothèque pour bureaux en épi\_Librería para alas de extensión de mesa

L240 P40 H62  
64-7R58

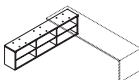

Esempi di composizioni\_Combination example, Aufbau-Beispiele, Exemples de compositions, Ejemplos de composición

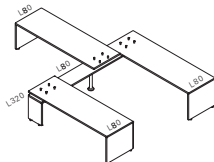
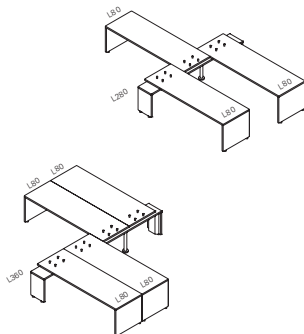
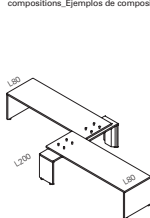

Consigli d'uso degli accessori, in composizioni con tavoli molto lunghi\_Recommended uses of accessories in compositions with extra long tables\_Empfehlung für den Einsatz von Zubehör bei sehr langen Tischkombinationen\_Conseils d'utilisation des accessoires, dans des compositions avec bureaux très longs\_Consejos para el uso de accesorios en composiciones con mesas muy largas

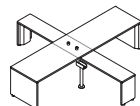
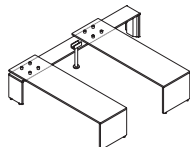
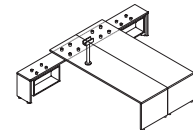
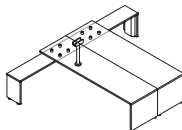

Tavolo rettangolare, Rectangular desk, Rechteckiger Tisch, Bureau rectangulaire, Mesa rectangular

P80 H72  
64-1R08 L 80 64-1R16 L 160  
64-1R12 L 120 64-1R18 L 180  
64-1R14 L 140



[\*] Tavolo sagomato (90°), Curved desk (90°), Bogenförmiger Tisch (90°), Bureau courbé (90°), Mesa curvada (90°)

P140 H72 64-2R82  
P160 H72 64-2R83



[\*] Tavolo sagomato (120°), Curved desk (120°), Bogenförmiger Tisch (120°), Bureau courbé (120°), Mesa curvada (120°)

L209 P70-111 H72  
64-2R91



Piano di collegamento 90°, 90° connecting top, Verbindungsplatte 90°, Plan de liaison 90°, Módulo de unión 90°

P80  
64-5R02

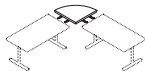

Tavolo rettangolare decorato, Decorated rectangular table, Rechteckiger Tisch in Dekorationsführung, Bureau rectangulaire décoré, Mesa rectangular decorada

P90 H72  
64-1R09 L 80 64-1R17 L 160  
64-1R13 L 120 64-1R19 L 180  
64-1R15 L 140



Tavolo sagomato (90°), Curved desk (90°), Bogenförmiger Tisch (90°), Bureau courbé (90°), Mesa curvada (90°)

P140 H72 64-2R84  
P160 H72 64-2R85



Tavolo sagomato (120°), Curved desk (120°), Bogenförmiger Tisch (120°), Bureau courbé (120°), Mesa curvada (120°)

L209 P70-111 H72  
64-2R97



Piano terminale, End unit, Abschlussplatte, Plateau d'extension, Módulo terminal de extensión

L80 P40  
64-5R03



[\*] Tavolo sagomato (90°), Curved desk (90°), Bogenförmiger Tisch (90°), Bureau courbé (90°), Mesa curvada (90°)

P140 H72 64-2R80  
P160 H72 64-2R81



[\*] Tavolo sagomato (120°), Curved desk (120°), Bogenförmiger Tisch (120°), Bureau courbé (120°), Mesa curvada (120°)

L209 P70-111 H72  
64-2R90



Tavolo autonomo, Free-standing table, Freistehender Tisch, Bureau de autonome, Mesa autónoma

L120-60 P120-60 H72  
64-2R92



Tavolo sagomato (90°), Curved desk (90°), Bogenförmiger Tisch (90°), Bureau courbé (90°), Mesa curvada (90°)

P140 H72 64-2R78  
P160 H72 64-2R79



Tavolo di collegamento (120°), Curved desk (120°), Bogenförmiger Tisch (120°), Bureau courbé (120°), Mesa curvada (120°)

L209 P70-111 H72  
64-2R96



Tavolo di collegamento, Connecting table, Verbindungsstück, Bureau de liaison, Mesa de unión

L120-60 P120-60 H72  
64-2R93



[\*] Non disponibile per il mercato francese  
Not available for the French market  
Für Frankreich nicht erhältlich  
Pas disponible pour le marché français  
No disponible para el mercado francés

Tavolo rettangolare, Rectangular desk, Rechteckiger Tisch, Bureau rectangulaire, Mesa rectangular

P80 H72  
64-2R08 L 80 64-2R16 L 160  
64-2R12 L 120 64-2R18 L 180  
64-2R14 L 140



Cassetiera a 3 cassetti, Drawer box with 3 drawers, Schubladenkasten mit 3 Laden, Caisson avec 3 tiroirs, Cajonera de 3 cajones

L42 P57 H58  
64-6R07



Set di 4 piedini fissi, Set of 4 fixed feet, Garnitur à 4 fixe FüÙe, Jeu de 4 pieds fixes, Juego de 4 pies fijos

Ø 5 H1,7  
53-9M93



Tavolo rettangolare, Rectangular table, Rechteckiger Tisch, Table rectangulaire, Mesa rectangular

P100 H72  
64-3R24 L 140  
64-3R26 L 160



Tavolo intermedio, Bureau intermédiaire, Intermediate desk, Bureau intermédiaire, Mesa intermedia

P80 H72  
64-2R58 L 80 64-2R66 L 160  
64-2R62 L 120 64-2R68 L 180  
64-2R64 L 140



Cassetiera, 1cassetto/1cassaf, Drawer box, 1 drawer/1 filing drawer, Schubladenkasten, 1 Lade/1 Kartellauszug, Caisson, 1 tiroir/1 classeur, Cajonera, 1 cajón, 1 carpetero

L42 P57 H58  
64-6R08



Tavolo riunione, Conference table, Konferenztisch, Table de réunion, Mesa de reunión

P120 H72 L240  
64-3R44



Tavolo con ruote, Table with casters, Tisch mit Rollen, Table avec roulettes, Mesa con ruedas

P80 H72  
64-3R09 L 80 64-3R17 L 160  
64-3R13 L 120 64-3R15 L 140



Tavolo dattilo, Typing desk, Schreibmaschinentisch, Table dactylo, Mesa dactilografía

P60 H72  
64-2R30 L 80  
64-2R31 L 100  
64-2R32 L 120



Cassetiera portante, 3 cassetti, Supporting drawer box, 3 drawers, Tragender Schubladenkasten, 3 Laden, Caisson porteur, 3 tiroirs, Cajonera de soporte, 3 cajones

L42 P57 H58+S  
64-6R87



Tavolo riunione decorato, Decorated conference table, Konferenztisch in Dekorationsführung, Mesa de reunión decorada, Mesa de reuniones

P120 H72 L240  
64-3R45



Tavolo con ruote, Table with casters, Tisch mit Rollen, Table avec roulettes, Mesa con ruedas

P100 H72  
64-3R25 L 140  
64-3R27 L 160



Tavolo intermedio, Intermédiaire desk, Zwischentisch, Bureau intermédiaire, Mesa intermedia

P60 H72  
64-2R40 L 80  
64-2R41 L 100  
64-2R42 L 120



Cassetiera portante, 1 cassetto/1 cassaf, Supporting drawer box, 1 drawer/1 filing drawer, Tragender Schubladenkasten, 1 Lade/1 Kartellauszug, Caisson porteur, 1 tiroir/1 classeur, Cajonera de soporte, 1 cajón/1 carpetero

L42 P57 H58+S  
64-6R88



Tavolo rettangolare, Rectangular table, Rechteckiger Tisch, Table rectangulaire, Mesa rectangular

P80 H72  
64-3R08 L 80 64-3R16 L 160  
64-3R12 L 120  
64-3R14 L 140



Piano rettangolare, Rectangular top, Rechteckige Platte, Plateau rectangulaire, Tablero rectangular

P80  
64-PR20 L 80 64-PR64 L 80  
64-PR22 L 120 64-PR45 L 100  
64-PR24 L 140 64-PR46 L 120  
64-PR26 L 160  
64-PR28 L 180

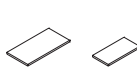

Tavolo tondo\_Round table\_Runder Tisch\_Table ronde\_Mesa redonda

Ø90 H72  
64-3R31



Tavolo rettangolare, regolabile, Rectangular table, adjustable, Rechteckiger Tisch, verstellbar, Bureau rectangulaire, réglable, Mesa rectangular, regulable

P80 H72-120  
64-TR14 L 140  
64-TR16 L 160  
220V ~50Hz 400W



Schermo per CPU, Computer screening panel, Abschirmung für Computer\_Panneau pour ordinateur\_Panel para ordenador

L19 P5 H40  
64-9R59



Piano di lavoro sagomato (90°)\_Curved worktop (90°)\_Arbeitsplatte, bogenförmig (90°)\_Plan de travail courbe (90°)\_Tablero curvado (90°)

L140 P140 64-PR30  
L160 P160 64-PR31



Tavolo tondo con ruote\_Round table with casters, Runder Tisch mit Rollen, Table ronde avec roulettes, Mesa redonda con ruedas

Ø90 H72  
64-3R41



Tavolo ovale, regolabile, Oval table, adjustable, Ovaler Tisch, verstellbar, Bureau ovale, réglable, Mesa ovalada, regulable

P80 H72-120  
64-TR26 L 160  
220V ~50Hz 400W



Pannello frontale metallico, Metal front panel, Metallisches Frontpaneel, Panneau frontal métallique, Panel frontal metálico

L100 P8 H32,5  
64-9R60



Piano di lavoro sagomato (120°)\_Curved worktop (120°)\_Arbeitsplatte, bogenförmig (120°)\_Plan de travail courbe (120°)\_Tablero curvado (120°)

L209 P70-111  
64-PR34



*Non disponibile per il mercato francese  
Not available for the french market  
Für Frankreich nicht erhältlich  
Pas disponible pour le marché français  
No disponible para el mercado francés*

Tavolo tondo\_Round table\_Runder Tisch\_Table ronde\_Mesa redonda

Ø120 H72  
64-3R32



Tavolo sagomato, regolabile, Curved table, adjustable, Bogenförmiger Tisch, verstellbar, Bureau courbe, réglable, Mesa curvada, regulable

L160 P80 H72-120  
64-TR36  
220V ~50Hz 400W



Libreria home office, Home office bookcase, Bücherschrank home office, Bibliothèque home office, Librería home office

L 135 P45-70 H161,7  
64-8R21



Piano di lavoro sagomato (120°)\_Curved worktop (120°)\_Arbeitsplatte, bogenförmig (120°)\_Plan de travail courbe (120°)\_Tablero curvado (120°)

L209 P70-111  
64-PR36



*Non disponibile per il mercato francese  
Not available for the french market  
Für Frankreich nicht erhältlich  
Pas disponible pour le marché français  
No disponible para el mercado francés*

Tavolo ovale, Oval table, Ovaler Tisch, Table ovale, Mesa ovalada

L140 P80 H72  
64-3R33



Piano per CPU, Computer stand, Computer-Auflageplatte, Plateau pour ordinateur, Soporte para ordenador

L45 P22 H57,5  
64-9R92



Piano di lavoro sagomato (90°)\_Curved worktop (90°)\_Arbeitsplatte, bogenförmig (90°)\_Plan de travail courbe (90°)\_Tablero curvado (90°)

L140 P140 64-PR32  
L160 P160 64-PR33



Piano di lavoro \_Worktop, Arbeitsplatte, Plan de travail, Tablero

L120-60 P120-60  
64-PR35



*Non disponibile per il mercato francese  
Not available for the french market  
Für Frankreich nicht erhältlich  
Pas disponible pour le marché français  
No disponible para el mercado francés*

Piano di lavoro a misura\_Custom worktop, Arbeitsplatte nach Maß, Plan de travail sur mesure, Tablero a medida

H 6,5 L max.300cm  
64-PR10 P 100  
64-PR08 P 80  
64-PR06 P 60

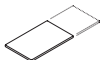

Base a T ridotta, Reduced T-shaped base, Fußgestell T-förmig, reduziert, Piétement T réduit, Apoyo en T reducido

L12 P50 H72  
64-8R82  
64-8R83

pezzi 1  
pezzi 2



Pannello schermo vetro sabbato, Matt-finish screen panel, Abschirmpaneel aus Mattglas, Panneau écran satiné, Panel separador vidrio arenado

H40 P0,5

64-4R22 L 119  
64-4R24 L 139  
64-4R26 L 159

64-4R28 L 179  
64-4R30 L 199



Pannello con binario alluminio\_Panel with aluminium rail\_Paneel mit Aluminiumschiene, Panneau avec rail en aluminium\_Panel con guía en aluminio

H50 P2,8

64-4R82 L 119  
64-4R84 L 139  
64-4R86 L 159

64-4R88 L 179  
64-4R90 L 199



Base cilindrica, Cylindrical base, Zylinderförmiges Fußgestell, Piétement cylindrique, Apoyo cilíndrico

Ø6 H72  
64-8R84



Base a T regolabile, T-shaped base, Fußgestell T-förmig, verstellbar, Piétement T, réglable, Apoyo en T regulable

L12 P68 H67-77  
64-8R90  
64-8R91

pezzi 1  
pezzi 2



Pannello schermo vetro sabbato, Matt-finish screen panel, Abschirmpaneel aus Mattglas, Panneau écran satiné, Panel separador vidrio arenado

H40 P0,5

64-4R32 L 119  
64-4R34 L 139  
64-4R36 L 159

64-4R38 L 179  
64-4R40 L 199



Pannello schermo bifronte, Double sided screen pane, Doppelseitiges Abschirmpaneel, Panneau écran biface, Panel separador doble frente

H50 P1,8

64-4R53 L 119  
64-4R55 L 139  
64-4R57 L 159

64-4R59 L 179  
64-4R61 L 199



Base cilindrica, regolabile, Cylindrical base, adjustable, Zylinderförmiges Fußgestell, verstellbar, Piétement cylindrique, réglable, Apoyo cilíndrico, regulable

Ø6 H67-77  
64-8R94



Base a T ridotta, Reduced T-shaped base, Fußgestell T-förmig, reduziert, verstellbar, Piétement T réduit, réglable, Apoyo en T reducido, regulable

L12 P50 H67-77  
64-8R92  
64-8R93

pezzi 1  
pezzi 2



Pannello schermo nobilitato, Melamine screen panel, Melamin-Abschirmpaneel, Panneau écran mélaminé, Panel separador melaminico

H50 P1,8

64-4R52 L 119  
64-4R54 L 139  
64-4R56 L 159

64-4R58 L 179  
64-4R60 L 199



Pannello schermo bifronte, Double sided screen pane, Doppelseitiges Abschirmpaneel, Panneau écran biface, Panel separador doble frente

H50 P1,8

64-4R63 L 119  
64-4R65 L 139  
64-4R67 L 159

64-4R69 L 179  
64-4R71 L 199



Base a T, T-shaped base, Fußgestell T-förmig, Piétement T, Apoyo en T

L12 P68 H72  
64-8R80  
64-8R81



Pannello schermo fluorescente, Fluorescent screen panel, Abschirm-Leuchtpanel, Panneau écran fluorescent, Panel separador fluorescente

H40,5 P0,5  
64-4R12 L 119  
64-4R14 L 139  
64-4R16 L 159

64-4R18 L 179  
64-4R20 L 199



Pannello schermo nobilitato, Melamine screen panel, Melamin-Abschirmpaneel, Panneau écran mélaminé, Panel separador melaminico

H50 P1,8

64-4R62 L 119  
64-4R64 L 139  
64-4R66 L 159

64-4R68 L 179  
64-4R70 L 199



Pannello schermo bifronte, Double sided screen pane, Doppelseitiges Abschirmpaneel, Panneau écran biface, Panel separador doble frente

H50 P2,8

64-4R83 L 119  
64-4R85 L 139  
64-4R87 L 159

64-4R89 L 179  
64-4R91 L 199



Contenitore a giorno\_Open-fronted cabinet\_Offener Schrank\_Armoire ouverte\_Armario sin puertas

L45 P43  
64-7R00 H 81,7  
64-7R10 H 121,7  
64-7R20 H 161,7



Cont. a giorno con decori doppi. Open cabinet with dbl decor. Off. Schrank mit beids. Dekor\_Arm. ouverte décors doubles\_Arm. s/puertas con decor. doubles

L45 P43  
64-7D00 H 81,7  
64-7D10 H 121,7  
64-7D20 H 161,7



Cont. ante legno con decori a DX. Woodend-door cabinet with right decor. Off. Schrank Holz. Dekor RSr\_Arm. porte bois décors à D\_Arm. puerta madera decor. dcha.

L45 P45  
64-7D34 H 81,7  
64-7D44 H 121,7  
64-7D54 H 161,7



Cont. ante vetro con decori a SX. Glass-door cabinet with left decor. Schrank Glas. Dekor LS\_Arm. porte vitrée décors à G\_Arm. puerta acristalada decor. izda.

L45 P44  
64-7D69 H 81,7  
64-7D79 H 121,7  
64-7D89 H 161,7



Contenitore ante legno (dx)\_Cabinet with wooden door (rh)\_Schrank mit Holzüre (re)\_Armoire porte bois (d)\_Armario puerta de madera (dx)

L45 P45  
Dx  
64-7R04 H 81,7  
64-7R14 H 121,7  
64-7R24 H 161,7



Cont. a giorno con decori a Dx. Open cabinet with right decor. Off. Schrank mit Dekor RS\_Arm. ouverte décors à D\_Arm. s/puertas con decor. a dcha.

L45 P43  
64-7D60 H 81,7  
64-7D70 H 121,7  
64-7D80 H 161,7



Cont. ante legno con decori a SX. Woodend-door cabinet with left decor. Schrank Holz. Dekor LS\_Arm. porte bois décors à G\_Arm. puerta madera decor. izda.

L45 P45  
64-7D64 H 81,7  
64-7D74 H 121,7  
64-7D84 H 161,7



Contenitore a giorno\_Open-fronted cabinet\_Armoire ouverte\_Armario sin puertas

L90 P43  
64-7R01 H 81,7  
64-7R11 H 121,7  
64-7R21 H 161,7



Contenitore ante vetro\_Cabinet with glass door\_Schrank mit Glasüre\_Armoire porte vitrée\_Armario puerta acristalada

L45 P44  
64-7R09 H 81,7  
64-7R19 H 121,7  
64-7R29 H 161,7



Cont. a giorno con decori a SX. Open cabinet with left decor. Off. Schrank mit Dekor LS\_Arm. ouverte décors à G\_Arm. s/puertas con decor. a izda.

L45 P43  
64-7D60 H 81,7  
64-7D70 H 121,7  
64-7D80 H 161,7



Cont. ante vetro con decori doppi. Glass-door cabinet with dbl decor. Schrank Glas. beids. Dekor\_Arm. porte vitrée décors doubles\_Arm. puerta acristalada decor. dchb.

L45 P44  
64-7D09 H 81,7  
64-7D19 H 121,7  
64-7D29 H 161,7



Contenitore ante legno\_Cabinet with wooden doors\_Armoire portes bois\_Armario puertas de madera

L90 P43  
64-7R02 H 81,7  
64-7R12 H 121,7  
64-7R22 H 161,7



Ripiano per contenitori L45\_Cabinet shelf, L45\_Fachboden für Schrank L45\_Tablette pour armoires L45\_Estante para armarios L45

L41,3 P40 H2,2  
64-7R31 pezzi 1  
64-7R32 pezzi 2  
64-7R33 pezzi 3



Cont. ante legno (dx), con decori doppi. Woodend-door cabinet (rh), with dbl decor. Schrank Holz. (re) beids. Dekor\_Arm. porte bois (d), décors doubles\_Arm. puerta madera (dx), decor. dchb.

L45 P45  
Dx  
64-7D04 H 81,7  
64-7D14 H 121,7  
64-7D24 H 161,7



Cont. ante vetro (dx), con decori a DX. Glass-door cabinet with right decor. Schrank Glas. Dekor RS\_Arm. porte vitrée décors à D\_Arm. puerta acristalada decor. dcha.

L45 P44  
64-7D39 H 81,7  
64-7D49 H 121,7  
64-7D59 H 161,7



Contenitore ante vetro\_Cabinet with glass doors\_Armoire portes vitrées\_Armario puertas acristaladas

L90 P44  
64-7R03 H 81,7  
64-7R13 H 121,7  
64-7R23 H 161,7



Ripiano per contenitori L90\_Cabinet shelf, L90\_Fachboden für Schrank L90\_Tablette pour armoires L90\_Estante para armarios L90

L86,3 P40 H2,2  
64-7R51 pezzi 1  
64-7R52 pezzi 2  
64-7R53 pezzi 3



Cont. a giorno con decori a SX. Open cabinet with left decor. Schrank Holz. beids. Dekor\_Arm. ouverte décors à G\_Arm. s/puertas con decor. a izda.

L90 P43  
64-7D71 H 81,7  
64-7D81 H 161,7



Cont. ante vetro con decori doppi. Glass-door cabinet with left decor. Schrank Glas. beids. Dekor\_Arm. portes vitrée décors doubles\_Arm. puertas acristalada decor. dchb.

L90 P44  
64-7D03 H 81,7  
64-7D13 H 121,7  
64-7D23 H 161,7



Anta per contenitori, con serratura\_Door for cabinets, with lock\_Tür für Schränke, mit Sperrung\_Porte pour armoires, avec serrure\_Puerta para armarios, con cerradura

L45 P2  
Dx  
64-7R81 H 81,7  
64-7R84 H 121,7  
64-7R86 H 161,7



Ripiano metallico per contenitori L90\_Metal shelf for cabinets, L90\_Metallfachboden für Schränke L90\_Tablette métallique pour armoires L90\_Estante metálico para armarios L90

L86,3 P40 H2,5  
64-9E51 pezzi 1  
64-9E52 pezzi 2



Cont. ante legno con decori doppi. Woodend-doors cabinet with dbl decor. Schrank Holz. Dekor RS\_Arm. portes bois décors doubles\_Arm. puertas madera decor. dchb.

L90 P45  
64-7D02 H 81,7  
64-7D12 H 121,7  
64-7D22 H 161,7



Cont. ante vetro con decori a DX. Glass-door cabinet with right decor. Schrank Glas. Dekor RS\_Arm. portes vitrée décors à D\_Arm. puertas acristalada decor. dcha.

L90 P44  
64-7D33 H 81,7  
64-7D43 H 121,7  
64-7D53 H 161,7



Coppia ante, con serratura\_Pair of doors, with lock\_Türen (Paar), mit Sperrung\_Paire de portes, avec serrure\_Par de puertas, con cerradura

L90 P2  
64-7R62 H 81,7  
64-7R64 H 121,7  
64-7R66 H 161,7



Cont. a giorno con decori doppi. Open cabinet with dbl decor. Off. Schrank m. beids. Dekor\_Arm. ouverte décors doubles\_Arm. s/puertas con decor. doubles

L90 P43  
64-7D01 H 81,7  
64-7D11 H 121,7  
64-7D21 H 161,7



Cont. ante legno con decori a DX. Woodend-doors cabinet with right decor. Schrank Holz. Dekor LS\_Arm. portes bois décors à D\_Arm. puertas madera decor. dcha.

L90 P45  
64-7D32 H 81,7  
64-7D42 H 121,7  
64-7D52 H 161,7



Cont. ante vetro con decori a SX. Glass-door cabinet with left decor. Schrank Glas. Dekor LS\_Arm. portes vitrée décors à G\_Arm. puertas acristalada decor. izda.

L90 P44  
64-7D63 H 81,7  
64-7D73 H 121,7  
64-7D83 H 161,7



Coppia ante per sovrapposizione. Pair of doors for stacking\_Türen (Paar) für Montage übereinander\_Paire de portes pour superposition\_Par de puertas para sobreposición

L90 P2  
64-8R62 H 81,7  
64-8R64 H 121,7



Cont. a giorno con decori a DX. Open cabinet with right decor. Off. Schrank m. Dekor RS\_Arm. ouverte décors à D\_Arm. s/puertas con decor a dcha.

L90 P43  
64-7D31 H 81,7  
64-7D41 H 121,7  
64-7D51 H 161,7



Cont. ante legno con decori a SX. Woodend-doors cabinet with left decor. Schrank Holz. beids. Dekor\_Arm. portes bois décors à G\_Arm. puertas madera decor. izda.

L90 P45  
64-7D62 H 81,7  
64-7D72 H 121,7  
64-7D82 H 161,7



Classificatore con 2 cassetti, prof. 33. Filing drawer box with 2 drawers, depth 33. Aktenmöbel mit 2 Laden, Tiefe 33. Classeur avec 2 tiroirs, prof. 33. Carpetero con 2 cajones, prof. 33

L90 P45 H81,7  
64-7R88



Top per contenitori\_Top for cabinets\_Schrankoberplatte\_Dessus pour armoires\_Encimera para armarios

P45 H1,8  
64-7R40 L 45  
64-7R41 L 90  
64-7R42 L 135



64-7R45 L 180  
64-7R46 L 225  
64-7R47 L 270

Cestone metalico con fondo, Large metal basket with bottom, Metallkorb mit Boden, Casier metallique avec fond, Gaveta metálica con fondo

L90-86 P33 H20  
53-CM05



Pannello plexiglas, Plexiglas screen panel, Frontpaneel aus Plexiglas, Panneau écran plexiglas, Panel separador en plexiglas

H 30  
58-0L05 L 50 58-0L11 L 110  
58-0L07 L 70 58-0L13 L 130  
58-0L09 L 90 58-0L15 L 150  
58-0L17 L 170



Vaschetta cancelleria alluminio, Aluminium stationery tray, Schale für Bürountersilien, Aluminium, Bac plumier en aluminium, Bandeja para útiles en aluminio

L22 P31 H8 58-0L20  
L32 P22 H8 58-0L21  
L44 P31 H8 58-0L22  
L66 P66 H8 58-0L23



Vaschetta cancelleria plexiglas, Plexiglas stationery tray, Schale für Bürountersilien, Plexiglas, Bac plumier en plexiglas, Bandeja para útiles en plexiglas

L22 P31 H8 58-0L25  
L32 P22 H8 58-0L26



Accessorio reggilibri, Book stand accessory, Bücherständer, Accessoire servelivros, Accessorio de soporte libros

L44  
58-0L40



Cestello portacavi, Cable rack, Kabelkorb, Corbeille porte-câbles, Bandeja portacables

L40 P16,5 H5,5 64-9R81  
L96 P16,5 H5,5 64-9R82



Supporto porta CPU, Computer stand, Computer-Auflageplatte, Plateau pour ordinateur, Soporte para ordenador

L60 P21 H52-47  
64-9R20



Canalina salita cavl, Cable riser ducting, Vertikale Kabelführung, Conduit passe câbles, Canal pasacables

Ø 6 H58  
53-9M88



Canalina salita cavl, Cable riser ducting, Vertikale Kabelführung, Conduit passe câbles, Canal pasacables

Ø 6 H75  
55-9K75



Ruota per tavoli con freno, Caster for tables with brake, Gebremste Rolle für Tische, Roulette pour tables avec frein, Rueda para mesas con freno

H6 Ø5  
54-9A41



Set 4 ruote per cassettiere, Set of casters for drawer boxes, 4pcs., Garnitur 4 Rollen für Schubladenkästen, Jeu de 4 roulettes pour caissons, Juego de 4 ruedas para cajoneras

H6 Ø 5  
54-9A40



Elementi di collegamento, Connecting elements, Verbindungselemente, Éléments de liaison, Elementos de union

64-9R31

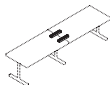

Coppia di collegamenti, piani a 90°, Pair of connecting brackets, for 90° tops, Halterungen für Platte 90° (Paar), Paire de supports pour plateaux à 90°, Par de elementos de unión tapas a 90°

64-9R96



Coppia supporti per piani, Pair of connecting brackets for tops, Stützwinkel für Platten (Paar), Paire de supports pour plateaux, Par de soportes para tapas

64-9R30



Vaschetta plexiglas, Plexiglas stationery tray, Schale für Bürountersilien, Plexiglas, Bac en plexiglas, Bandeja en plexiglas

L50 P33 H10  
64-9R40



Vaschetta polimero nero, Black polymer stationery tray, Schale für Bürountersilien, Polymer schwarz, Bac en polymère noir, Bandeja en polimero negro

L49 P32 H4,5  
64-9R50



Finiture  
Finishes  
Farben  
Finitions  
Acabados

Disponibilità di colori.  
Nell'ambito di ogni collezione non tutti gli articoli sono disponibili nei vari colori e finiture. Per un esatto controllo della disponibilità è consigliato l'uso del catalogo tecnico.

Colour availability.  
Not all the articles in each collection are available in the full range of colours. Please consult the technical catalogue for the exact colours available.

Verfügbare Farben.  
Innerhalb der einzelnen Kollektionen sind nicht alle Artikel in allen Farben erhältlich, die angeben sind. Um festzustellen, welche Farben jeweils verfügbar sind, bitte den technischen Katalog nachschlagen.

Disponibilité de couleurs.  
À l'intérieur de chaque collection, tous les articles ne sont pas disponibles dans les différentes couleurs énumérées. Pour un contrôle exact de la disponibilité, consulter le catalogue technique.

Disponibilidad de colores.  
En cada colección, no todos los artículos están disponibles en los distintos colores y acabados. Para controlar exactamente la disponibilidad se aconseja consultar el catálogo técnico.

Tavolo rettangolare, Rectangular table, Rechteckiger Tisch, Table rectangulaire, Mesa rectangular

GN \_Grigio nebbia, Misty grey, Nebelgrau, Gris brouillard, Gris niebla



GN \_Grigio nebbia, Misty grey, Nebelgrau, Gris brouillard, Gris niebla



RL \_Rovere Galles, Galles oak, Waliser Eiche, Chêne Galles, Roble Galles



Tavolo di servizio, Side table, Beistelltisch, Table de service, Mesa de servicio

YL \_Melaminico giallo, Yellow melamine, Gelb Melamin, Melaminé jaune, Melaminico amarillo



GE \_Melaminico glicine, Wisteria melamine, Flieder Melamin, Melaminé glycine, Melaminico glicina



AT \_Melaminico amaranzo, Amaranth melamine, Amarantröt Melamin, Melaminé amarante, Melaminico carmesi



VP \_Melaminico verde, Green melamine, Grün Melamin, Melaminé vert, Melaminico verde



VP \_Melaminico verde, Green melamine, Grün Melamin, Melaminé vert, Melaminico verde



GN \_Grigio nebbia, Misty grey, Nebelgrau, Gris brouillard, Gris niebla



GN \_Grigio nebbia, Misty grey, Nebelgrau, Gris brouillard, Gris niebla



**Cassettiera, 1cassetto, 1classif. Drawer box, 1 drawer, 1 filing drawer, Zwischentisch Cajon, 1 tiroir, 1 classeur, Cajonera, 1 cajón, 1 carpetero**

**RL** \_Rovere Galles \_Galles oak \_Waliser Eiche \_Chêne Galles \_Roble Galles



**YL** \_Melaminico giallo \_Yellow melamine Giallo Melamin \_Mélaminé jaune \_Melaminico amarillo



**GE** \_Melaminico glicine \_Wisteria melamine \_Flieder Melamin \_Mélaminé glycine \_Melaminico glicina



**AT** \_Melaminico amaranto \_Amaranth melamine \_Amarantrot Melamin \_Mélaminé amarante \_Melaminico carmesi



**VP** \_Melaminico verde \_Green melamine Grün Melamin \_Mélaminé vert \_Melaminico verde



**GN** \_Grigio nebbia \_Misty grey \_Nebelgrau \_Gris brouillard \_Gris niebla



**Pannello schermo fluorescente \_Fluorescent screen panel \_Abschirm-Leuchtpanel \_Panneau écran fluorescent \_Panel separador fluorescente**



**Pannello schermo nobilitato \_Melamine screen panel \_Melamin-Abschirmpanel \_Panneau écran mélaminé \_Panel separador melaminico**



**Pannello schermo nobilitato \_Melamine screen panel \_Melamin-Abschirmpanel \_Panneau écran mélaminé \_Panel separador melaminico**



**Pannello schermo vetro sabbiato \_Matt-finish screen panel \_Abschirmpanel aus Mattglas \_Panneau écran satiné \_Panel separador vidrio arenado**



**Pannello schermo vetro sabbiato \_Matt-finish screen panel \_Abschirmpanel aus Mattglas \_Panneau écran satiné \_Panel separador vidrio arenado**

